

## MIKROKYTKIN V4 KAKSIKÄRKINEN

Pienois mikrokytkin

83132030

Mikrokytkin, CO, W2

- 1 NC + 1 NO
- Liittimet kolmeen eri suuntaan
- Mahdollista vaikuttaa useampaan kytkimeen samalla painalluksella

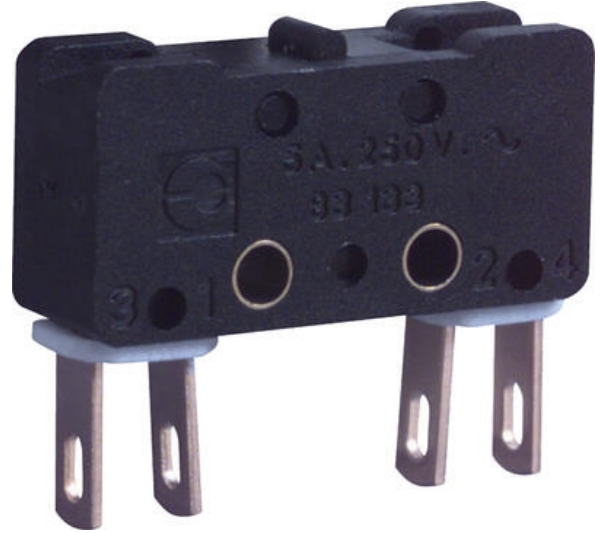

### TUOTEKUVAUS

Tässä sarjassa on koskettimet 1NO+1NC ja sivussa tai takana olevat liittimet. Saatavana hetitoimivana tai bistabiilitoiminnolla. Laaja valikoima toimipäitä.

Mikrokytkimiä käytetään, kun tila on pieni tai edellytetään kustannustehokasta ratkaisua. Mikrokytkimet soveltuvat aina teollisuussovelluksista kotitaloustuotteisiin.

;

## TEKNISET TIEDOT

### TIEDOT

Koskettimet	1 NO, 1 NC
IP-luokka	IP40
Liitäntä	W2
Nimellisvirta 250 V AC	6 A
Nimellisvirta, 250 V AC	10 A
Min. käyttölämpötila	-40 °C
Max. käyttölämpötila	125 °C
Max. lepoasento	8,45 mm
Max. ohjausvoima	1,6 N
Min. jälkiliikevoima	0,27 mm
Min. paluuliikkeen voima	0,4 N
Max. hystereesi	0,45 mm

Max. jälkiliikevoima	10 N
KytKentäpiste	7,7±0,2 mm
KytKentäväli	0,3 x 2 mm

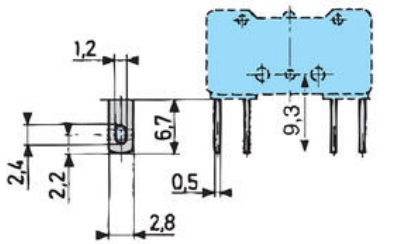

83 132 0

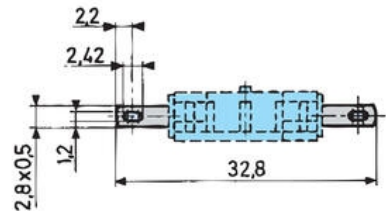
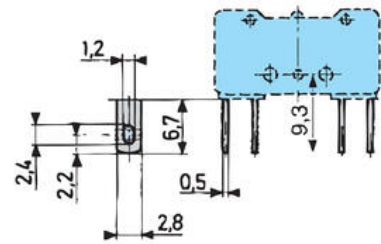
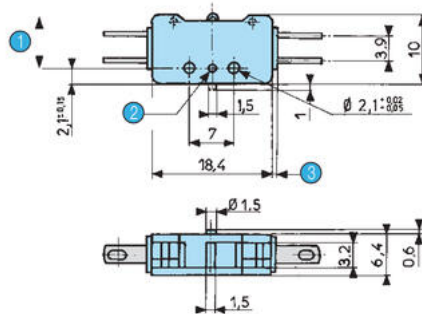

- 1 OL = 7.4
- 2 Ø1.5 depth 0.7
- 3 2 plates 0.8

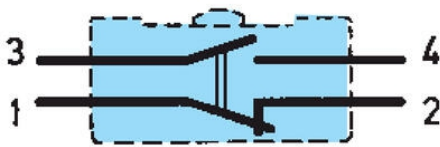
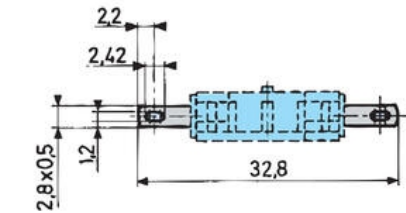

83 133 0

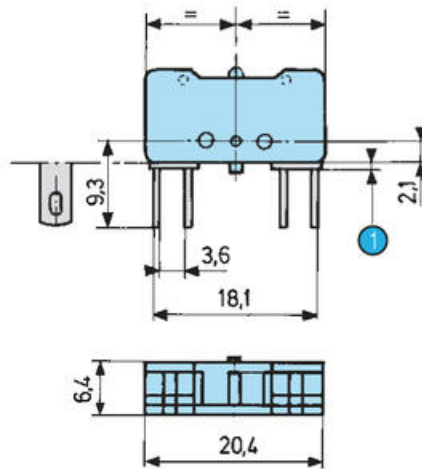

54E

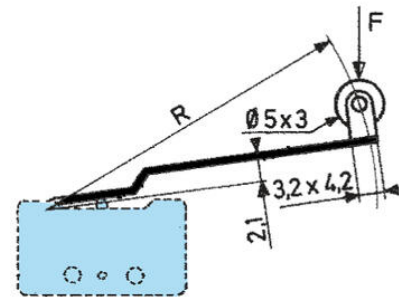

- 1 2 plates 0.8

54A

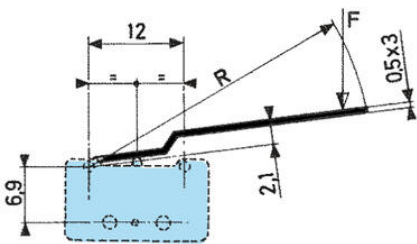

Operating curve for type 83 132 0 - 83 133 0 - 83 134 0

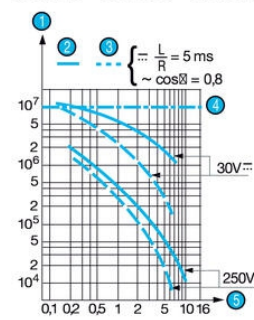

- 1 Number of cycles
- 2 Resistive load
- 3 Inductive load
- 4 Mechanical life
- 5 Current (A)

83 134 0

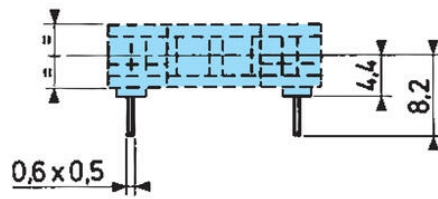
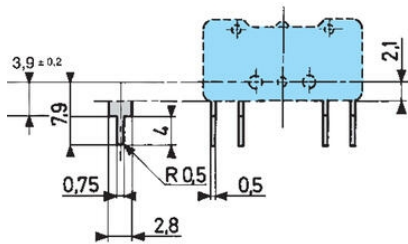
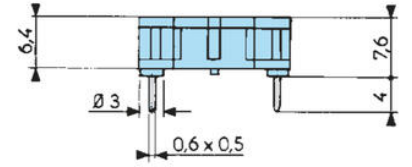
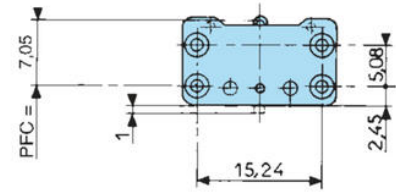

54B

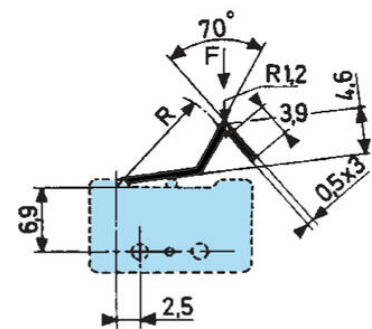

54A2

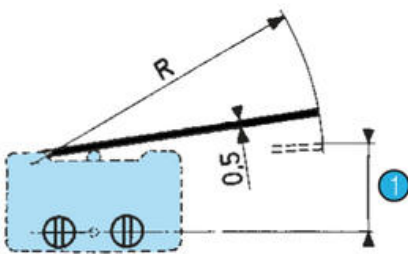

54A3

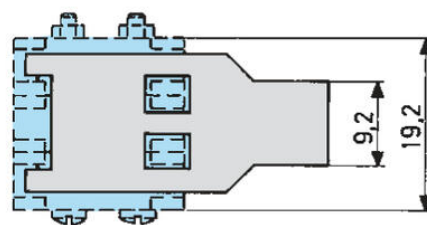

For 83 132 0 och 83 133 0

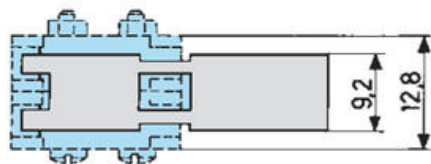
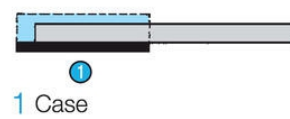

1 Switching point

For 83 134 0

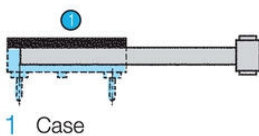



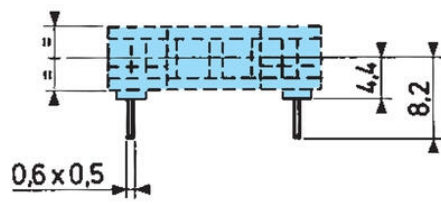
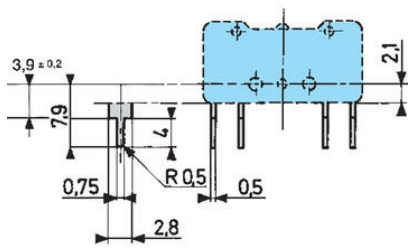

54B

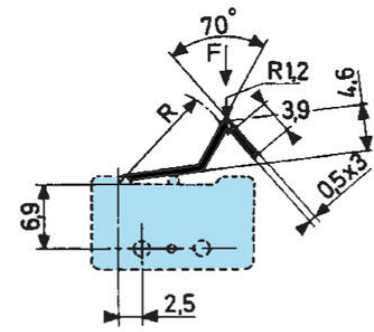

54A2

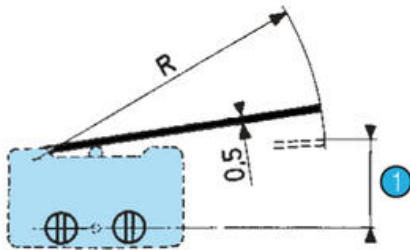

54A3

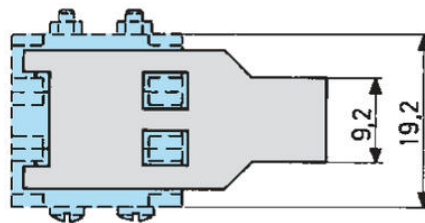

For 83 132 0 och 83 133 0

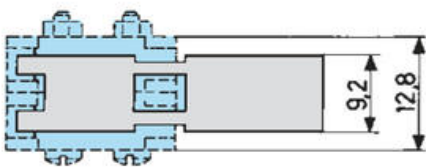
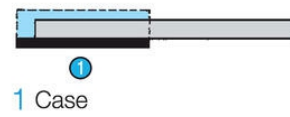

1 Switching point

For 83 134 0

