

# CYLINDRICAL

FUSE LINKS & FUSE HOLDERS/BASES



# PMX

industrial modular fuse holders  
for cylindrical fuse links

PMX

14x51



8x32

10x38

14x51

22x58

22x65

# PROTECTING THE WORLD

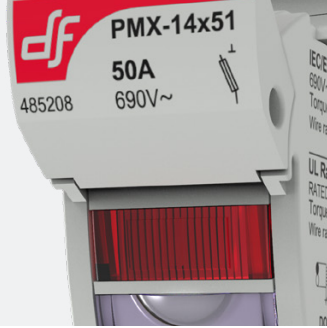

RATED CURRENT  
50A

RATED VOLTAGE  
690V AC  
750V DC

MAXIMUM POWER DISSIPATION  
6W

PROTECTION INDEX  
IP20

STANDARDS

IEC/EN 60269-1  
IEC/EN 60269-2  
UL 4248-1  
UL 486E  
CSA C22.2 N° 4248-1  
CSA 22.2 N° 65



## Industrial modular fuse holders for cylindrical fuse links

Modular fuse holder for cylindrical fuse link size 10x38 according IEC/EN 60269 standard.

Compact design, with reduced dimensions.

Ventilation zones optimized for a better heat dissipation.

Manufactured with a high quality materials

- Silver plated copper contacts.
- Plastic materials with high temperature resistance and self-extinguishable.
- All the materials are according to the European Directive RoHS.



Extended range of accessories is available.

UL certification (File E193529).



## Accessories

REFERENCE	DESCRIPTION	PACKING Uni /BOX
480005	PIN FOR MULTIPOLE ASSEMBLY	12/300
485356	HANDLE TIES FOR MULTIPOLE ASSEMBLY	12/300
485357	TIES FOR MICROSWITCH ASSEMBLY	12/300
485258	LOCK SUPPORT	5
485259	1P MICRO	5
485260	3P MICRO	2
485261	3P - DOUBLE MICRO	2
485262	MICRO 1P EXTENSION	5
485263	MICRO 3P EXTENSION	2
485264	FUSING INDICATOR REPLACEMENT 120/690V AC	3
485265	FUSING INDICATOR REPLACEMENT 24V DC	3
485266	SPECIAL IP20 PROTECTION ACCESSORY	12
485656	SCREWS PROTECTION ACCESSORY	20
485271	SPECIAL SCREW CONNECTION ACCESSORY	12
485272	PRE-BREAKING MODULE	6/90

## Range

U <sub>n</sub>	REFERENCE		POLES	MODULES	PACKING Uni /BOX
	WITHOUT INDICATOR	WITH INDICATOR			
690V AC 750V DC	485201 c	485208 c	1P	1,5	6/90
	485202 c	-	N	1,5	6/90
	485203 c	485209 c	1P + N	3	3/45
	485204 c	485210 c	2P	3	3/45
	485205 c	485211 c	3P	4,5	2/30
	485206 c	485212 c	3P + N	6	1/18
	485207 c	485213 c	4P	6	1/18
24V DC	-	485214 c	1P	1,5	6/90
	-	485215 c	1P + N	3	3/45
	-	485216 c	2P	3	3/45
690V AC 750V DC	WITH MICROSWITCH				
	PREBREAKING FUSING - PRESENCE	ONLY FUSION			
	485220 c	485226 c	1P	1,5	6/90
	485221 c	485227 c	1P + N	3	3/45
	485222 c	485228 c	2P	3	3/45
	485223 c	485229 c	3P	4,5	2/30
	485224 c	485230 c	3P + N	6	1/18
485225 c	485231 c	4P	6	1/18	

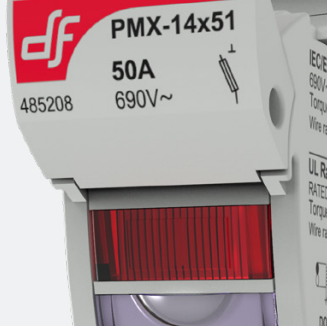

## Technical data

Rated current	50A	
Rated voltage	690V AC   750V DC <sup>IEC</sup> 750V AC <sup>UL-CSA</sup>	
Rated power dissipation	5W	
Maximum power dissipation	6W	
Power dissipation per pole	80% $I_n > 0,52W$ 100% $I_n > 0,88W$	
Utilization category as per EN 60947-3	AC-22B <sup>500V</sup> AC-21B <sup>690V</sup>	
Pollution degree	3	
Protection index ▶ FIG. 5	IP20	
Rated impulse withstand voltage	6kV U imp	
Ambient temperature of service	-40°C ... 70°C (with carrier operation) -50°C ... 80°C (without carrier operation)	
Storage temperature	-50°C ... 80°C	
Derating by number of poles	POLES	$I_{MAX}$
	1 ... 4	$I_n$
	5 ... 6	0,8 x $I_n$
	7 ... 9	0,7 x $I_n$
	≥ 10	0,6 x $I_n$
Correction of the admissible current in function of the temperature	20° C	1
	30° C	0,95
	40° C	0,90
	50° C	0,80
	60° C	0,70
	70° C	0,60

## Dimensions

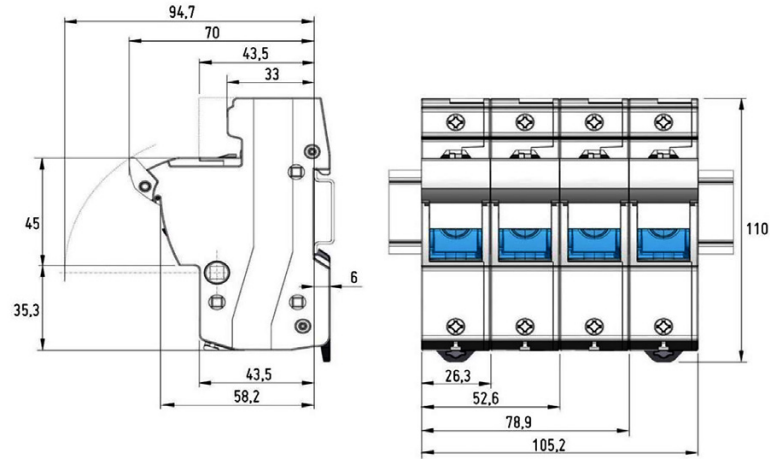

## Weight

	STANDARD   WITH INDICATOR	WITH MICROSWITCH
1P	101gr	107gr
N	110gr	-
1P + N	211gr	217gr
2P	202gr	214gr
3P	303gr	321gr
3P + N	413gr	431gr
4P	404gr	428gr

Weight without packing

## Standards

IEC/EN 60269-1  
IEC/EN 60269-2  
UL4248-1 Fuse holders  
UL486E Wiring terminals  
CSA C22.2 N° 4248-1 Fuse holder assemblies  
CSA 22.2 N° 65 Wire connectors

## Certifications



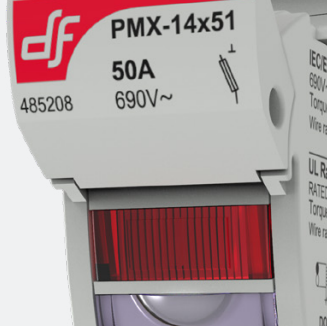

## Application characteristics

**For mounting on DIN/EN standard rail** DIN 46277/1-3 (EN50022)  
Clip fixation with 2 positions

**Connecting wire**  
Copper wires only

WIRES	METRIC	AWG	WIRING
1	1,5...35mm <sup>2</sup> Solid	8....16 AWG Solid	<p>14mm ±1</p>
	1,5...25mm <sup>2</sup> Stranded	6....16 AWG Stranded	
2 Same cross section and type	1,5...16mm <sup>2</sup> Solid	6....16 AWG Solid / Stranded	
	1,5...10mm <sup>2</sup> Stranded		

### Wire-end terminals

The use of wire-end terminals may allow to increase the connecting wire section.

Wire-end terminals recommended mounting:

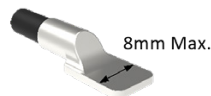

The use of wire-end terminals could not guarantee the IP20 protection degree.

### Ferrules

It's recommended use of ferrules in wires with section ≤ 2,5mm<sup>2</sup>



The product is delivered with the terminals opened and ready to connect

## Accessories

FIG. 1 | Multipolar assembly

Standard system by DF, 3 clips and 1 pin for each union between poles

- 480005** PINS FOR MULTIPOLE ASSE
- 485356** HANDLE TIES FOR MULTIPOLE ASSEMBLY
- 485357** TIES FOR MICROSWITCHES ASSEMBLY

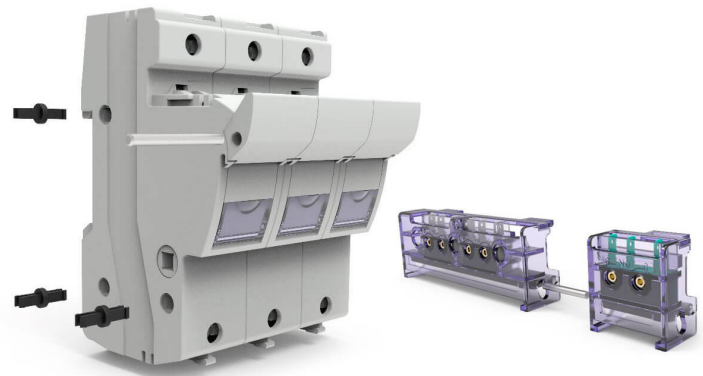
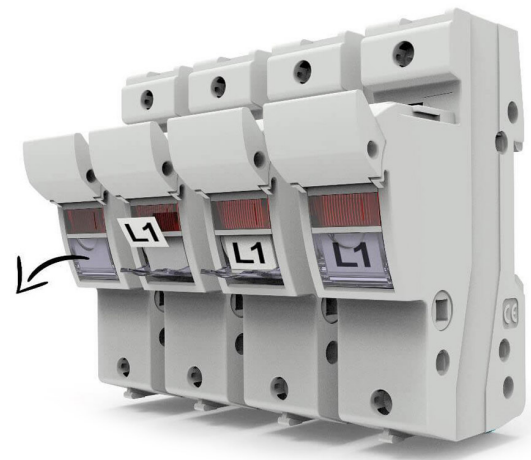

FIG. 2 | Identification by label

Open the label holder part with the fuse holder closed, put on the label and close it



Label measures **16x10mm**

**Tightening torque on terminals** 2,5...3 Nm  
22...27 lb.in

**Screws with a combined head** SLOT + PZ2

**Multipolar assembly** ► FIG. 1

**Fuse holders with fuse indicator**  
NEON 230...690V AC  
LED 12...24V DC  
30...60V DC

**Fuse holders with microswitch 5A - 250V**  
Both versions delivered with 3 pre-insulated terminals (fast-on 2,8 x 0,5)

NC(Normally closed) NO(Normally Open) contacts  
1. Fusing + pre-breaking + fuse link detection  
2. Only fusion  
- Only detection of fuse link operation  
- Also as accessory mounted on standard fuse holders

► FIG. 3

**Special zone for sealing** Ø1,5 mm wire

**Label holder for a better circuit identification** ► FIG. 2  
Suitable size for label: 16x10 mm

**Accessory available to lock the fuse holder by a padlock** ► FIG. 4  
(max. 3 padlocks of Ø 3mm)

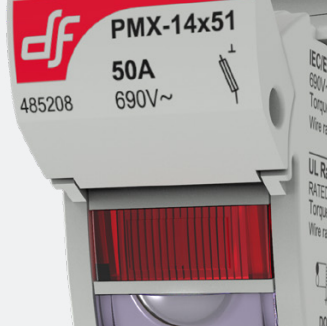

## Accessories

**FIG. 3 | Microswitch mounting**

Put on the microswitch on the guides, and push in horizontal movement to the final position.

\* For Only Fusion accessory, first mount the lifter in his place.

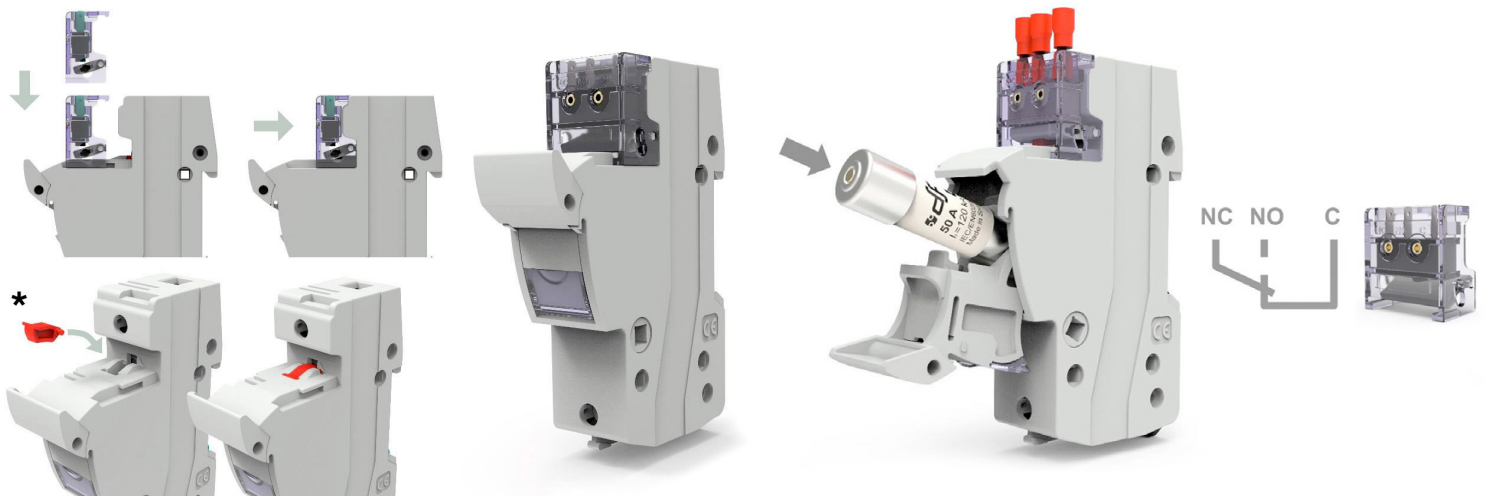

**FIG. 3.1 | Extension microswitch accessory**

Number of multipolar assemblies allowed with extension accessory microswitch unipolar: **max 2**

**485262** MICRO 1P EXTENSION



**x2 max**

Number of multipolar assemblies allowed with extension accessory microswitch tripolar: **max 1**

**485263** MICRO 3P EXTENSION

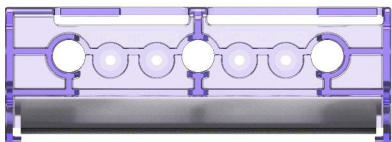

**x1 max**

### Accessory assembly

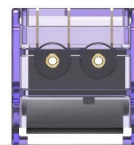

Microswitch

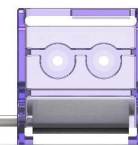

Extension accessory

### 2 Accessories assembly

Always one to each side of the microswitch

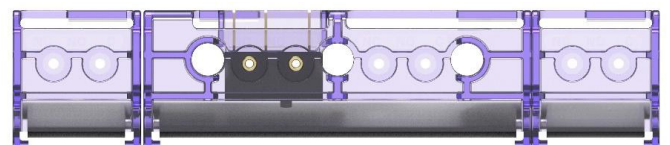
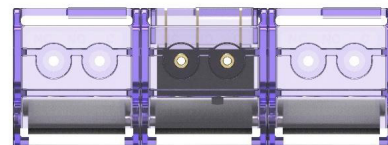

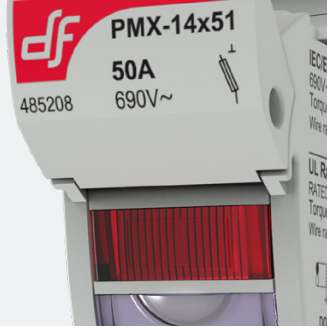

## Accessories

**FIG. 4 | Locking means a padlock**

To avoid the operation and connection when the fuse holder is open, put on the accessory "Padlock support" sliding it for the guides, and covering the fuse link zone.  
*(It's possible the use with or without fuse link)*

Introduce the padlock trough the symmetrical holes and close it.

**485258** LOCK SUPPORT



**FIG. 5 | Special IP20 protection**

The accessory must be positioned in the wire entries, if it's necessary to achieve the IP20 degree of protection with thin wires

**485266** SPECIAL IP20 PROTECTION ACCESSORY

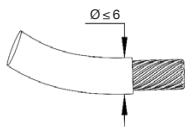

To obtain an IP20 rating with cable protection of  $\varnothing \leq 6\text{mm}$ , use the special protection accessory

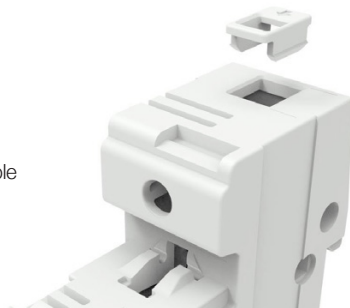
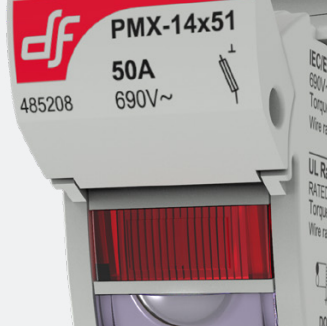

**FIG. 6 | Screws protection accessory**

Protection accessory to avoid the screws manipulation and improve the protection degree

**485656** SCREWS PROTECTION ACCESSORY





## Accessories

FIG. 8 | Special screw connection accessory

**485271** SPECIAL SCREW CONNECTION ACCESSORY

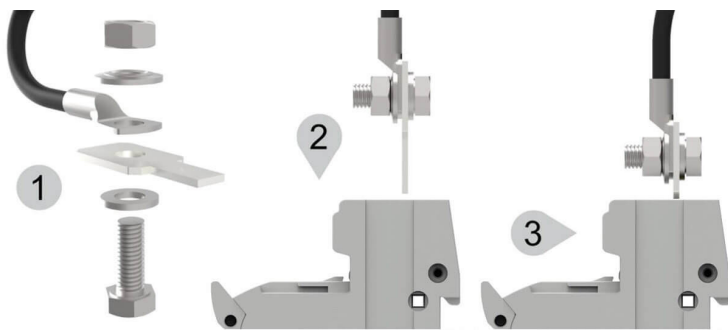

1

Mount the accessory  
in the wire (6Nm)

2

Wiring in the fuse holder

3

Apply tightening torque  
(2,5...3 Nm)

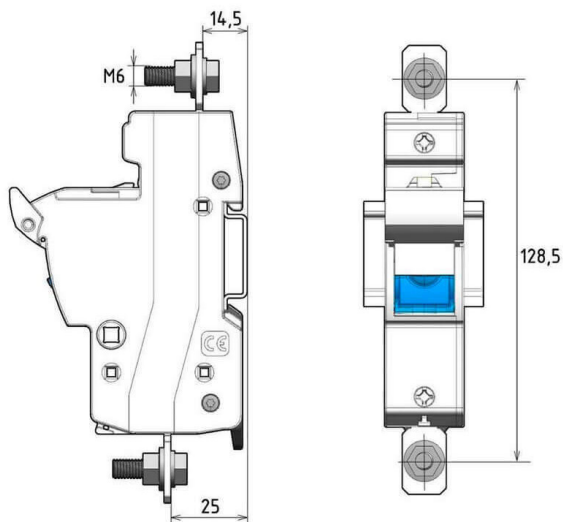

FIG. 9 | Fusing indicator replacement instructions

**485264** FUSING NEON INDICATOR REPLACEMENT 120/690V AC

**485265** FUSING INDICATOR REPLACEMENT 24 VDC

1

Open the fuse holder

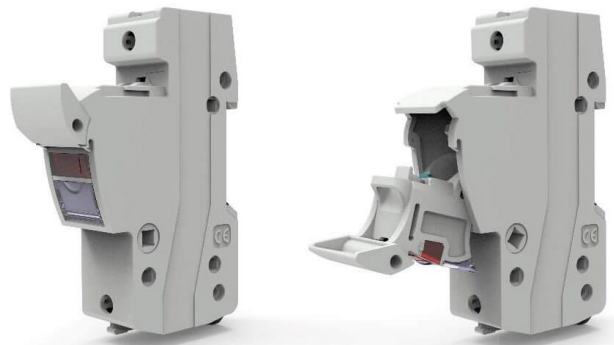

2

Using a flat screwdriver, remove the  
cover with a slight rotation of the tool

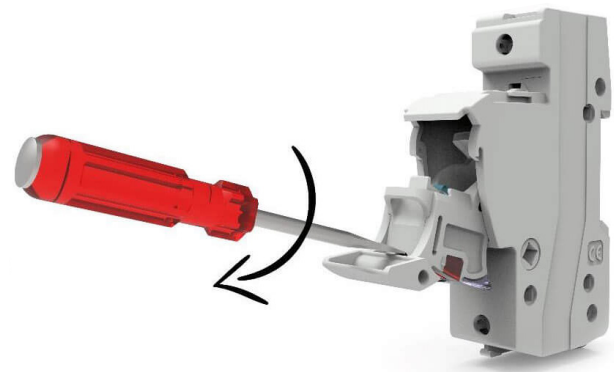

3

Replace the fusing indicator. Enter the  
cover on the handle with a slight angle

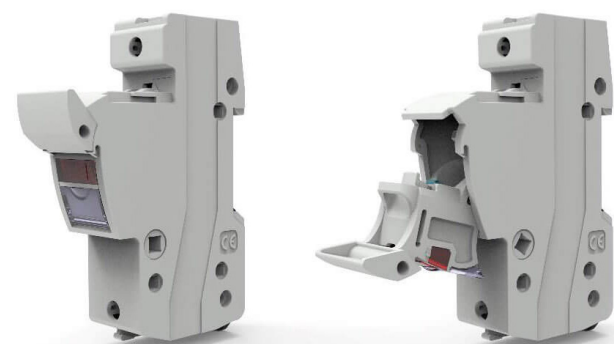

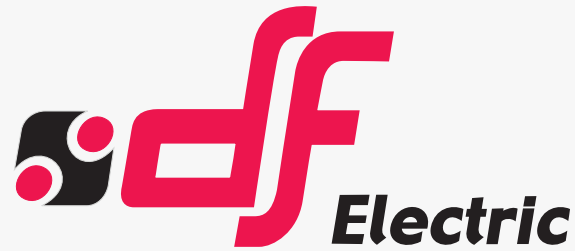

# PROTECTING THE WORLD

## HEAD OFFICE AND FACTORY

SILICI, 67-69  
08940 CORNELLA DE LLOBREGAT  
BARCELONA · SPAIN  
Tel. +34 93 377 85 85  
Fax +34 93 377 82 82

## INTERNATIONAL SALES

Tel. +34 93 475 08 64  
Fax +34 93 480 07 75  
export@dfelectric.es

## NATIONAL SALES

Tel. 93 475 08 64  
Fax 93 480 07 76  
comercial@dfelectric.es

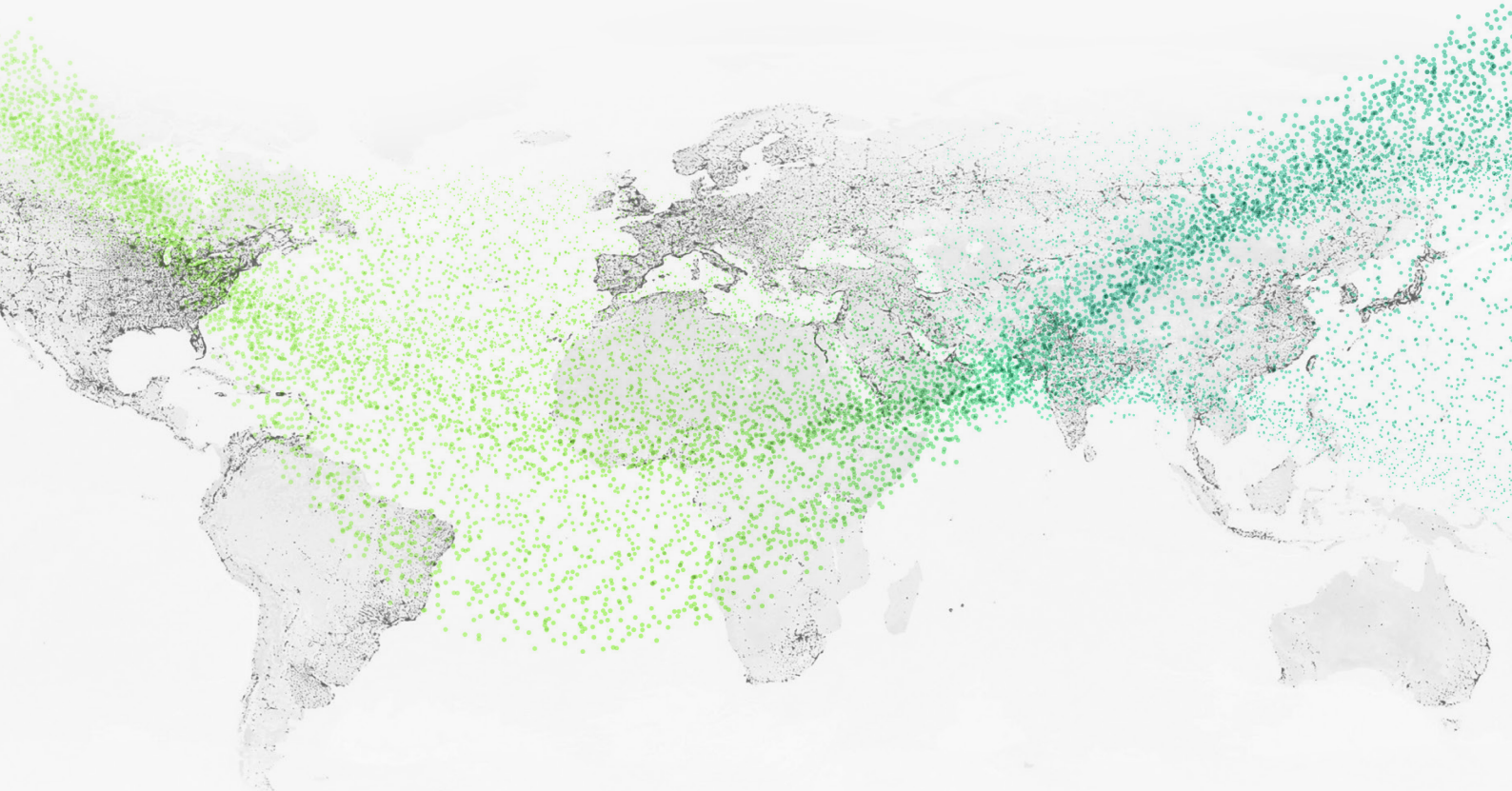

[dfelectric.es](http://dfelectric.es)



According to the waste of electrical and electronic equipment directive, electrical material should not be part of the usual waste. This symbol alerts users that these products should be recycled according to local environmental waste disposal regulations.



The "electro technical expert" logo marked on the products included in this data sheet indicates that the installation of these products must be carried out by expert personnel with specialized knowledge.



To prevent electrical hazards, carry out the installation without voltage.



**Safety notice**  
Please capture the following QR code and read our safety notice carefully before installing our products.



The data reflected in this technical record are subject to the correct installation of the product in accordance with manufacturer's instructions, relevant installation standards and professional practices, maintained and used in applications for which they were made.

The products described in this document have been designed, developed and tested in accordance with specific standard. They are considered components that are integrated as part of installation, machine or equipment. The correct general operation of the referred product is responsibility of the manufacturer of the installation, machine or equipment.

DF ELECTRIC cannot guarantee the characteristics of an installation, machine or equipment that has been designed by a third party. Once a product has been selected, the user must verify that it is appropriate for its application, through the verifications and/or tests that it deems appropriate.

DF ELECTRIC retains the right to change the dimensions, specifications, materials or design of its products at any time with or without notice.

©2023 DF Electric. All rights reserved