



Fan Accessories

專業製造風扇配件



- Wire Form, Metal Fan Guards
- Rib/Grille Fans
- Plastic Fan Guards
- Plastic Filter Kits
- Metal Fan Screens
- Ventilator Filter Kits



About PROWN Fan Accessories

Prown Electric Industries Co., Ltd./Taiwan and China invest in manufacturing, marketing services of hardware products, covering wire form finger guards, metal guards, metal grills, metal screens, fan filter kits, and type wire forms, punching nets, stamping wares.

Full range of metal or plastic finger guards and fan accessories suited for different sizes of fans, covering 1~20" (20~510mm) of cooling fans, ventilators, air movers...

PROWN- concentrate working on fan accessories production, and guard technics to meet demands of customers.

Contact Prown for professional services and proficient cooperation.

Index

Wire Form, Metal Fan Guards 鐵網	01
Rib / Grille Fans 裸 / 肋框網扇	03
Plastic Fan Guards 塑膠網	04
Plastic Filter Kits 塑膠濾網	05
Metal Fan Screens 金屬濾網	06
Ventilator Filter Kits 風機濾網組	07

Steel Wire Form Fan Guard Nomenclature



G60-4



G109-15CF-GD (BP)

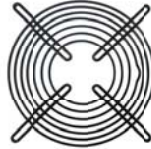

GK225-7UT

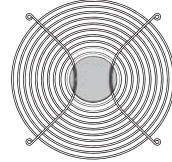

G254-9D

Model Information

G — **109** — **17** — **XX** ()

Prown Fan Guards, Grilles

G- Guard for standard axial fans
 GK- Guard for skeleton rib fans
 GL- Guard for grille fans
 GR- Guard for basket rim fans
 GP- Guard of push-on self lock

Surface plated Color

-xx = description of color
 () = Bright color plated
 no description
 -BK = Black color plated
 -WT= White color plated
 -GD = Golden color plated
 -RD = Red color plated
 -SV = Silver color plated

Sizes Model Series

25 ~ 25mm series fans
 40 ~ 40mm series fans
 50 ~ 50mm series fans
 60 ~ 60mm series fans
 70 ~ 70mm series fans
 80 ~ 80mm series fan
 92 ~ 90,92mm series fans
 109 ~ 119,120mm series fans
 127 ~ 127mm series fans
 160 ~ 160mm series fans
 172 ~ 172mm series fans
 180 ~ 180mm series fans
 200 ~ 200mm series fans
 205 ~ 205mm series fans
 225 ~ 225mm series fans
 254 ~ 254mm series fans
 280 ~ 280mm series fans
 300mm size above or
 Customer's design is acceptable & welcome!

Plating/RoHS/Spray protection

() = description of steel wires treatment
 () - Nickled chrome plated, bright (blank no description)
 (NU) - Noncopper nickled chrome plated
 (PS) - Plastics Spray Coting
 (SS) - Stainless Steel
 (ED) - Electro Deposit
 (BP) - Brass Plated
 (ZP) - Zine Plated
 (YZP) - Yellow Zine Plated
 (BZP) - Blue Zine Plated
 (SP72) - Salt spray test 72 hours approved

* Salt spray test normal 12 hours approved (blank, no description)

Wire Form, Metal Fan Guards 鐵網

Metal Fan Guards

Steel wires, electroplated finish cosmetics, nickel chrome plated, bright color.

Black color electro deposit available on request.

Welding joints strength to meet UL Standards minimum 40Kgs (88 lbs) separation force.

Patterned push-on type wire form metal guards are available on request.

Customer's design is acceptable & welcome!

25mm(1") G25-2U

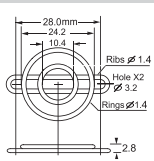

40mm(1.57") G40-2

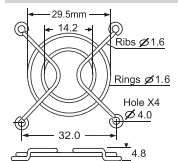

40mm(1.57") G40-2F

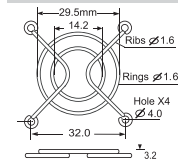

50mm(2") G50-3

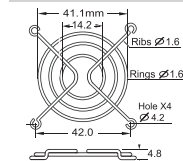

60mm(2.36") G60-4

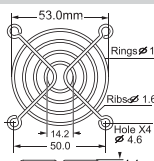

60mm(2.36") G60-4F

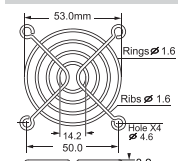

70mm(2.75") G70-5A

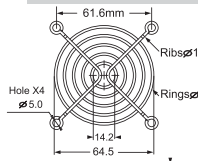

80mm(3.15") G80-18

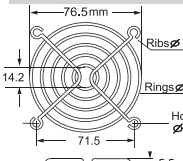

80mm(3.15") G80-5F

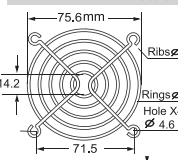

92mm(3.62") G92-13

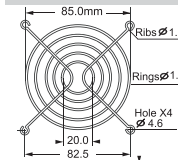

92mm(3.62") G92-16

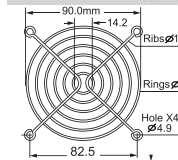

92mm(3.62") G92-6F

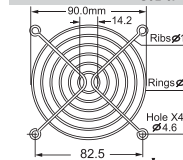

92mm(3.62") GK92-3UT2

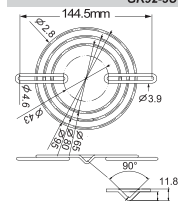

120mm(4.7") G109-15Z

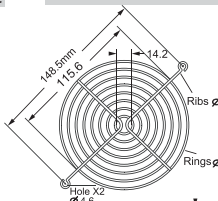

120mm(4.7") G109-15A

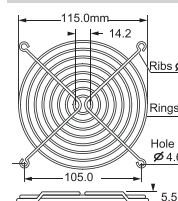

120mm(4.7") G109-15B

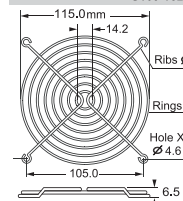

120mm(4.7") G109-15C

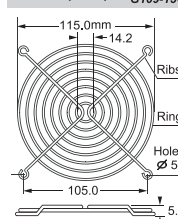

120mm(4.7") G109-15CF

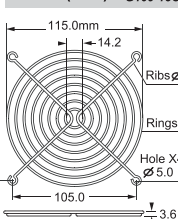

120mm(4.7") G109-17

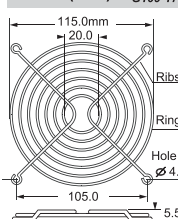

127mm(5") G127-9

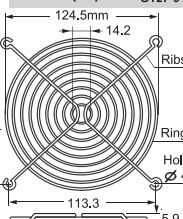

Wire Form, Metal Fan Guards 鐵網

Metal Fan Guards

Steel wires, electroplated finish cosmetics, nickel chrome plated, bright color.
Black color electro deposit available on request.
Welding joints strength to meet UL Standards minimum 40kgs (88 lbs) separation force.
Patterned push-on type wire form metal guards are available on request.
Customer's design is acceptable & welcome!

160mm(6.2") G160-8UF

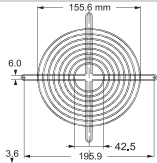

172mm(6.7") G172-5DU

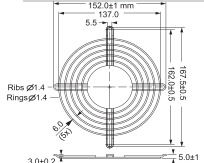

172mm(6.7") G172-6U

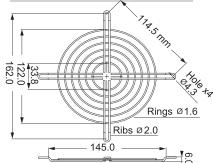

172mm(6.7") G172-6DU

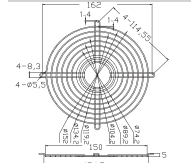

172mm(6.7") G172-7DU

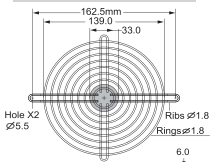

172mm(6.7") G172-8DU

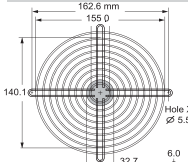

172mm(6.7") G172-7U2

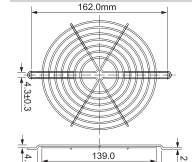

172mm(6.7") G172-10H

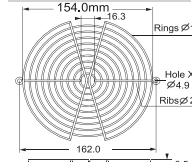

172mm(6.7") G172-10HA

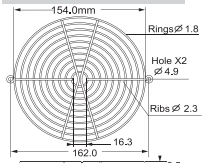

172mm(6.7") G172-10A

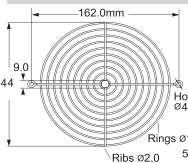

172mm(6.7") GK172-3UT

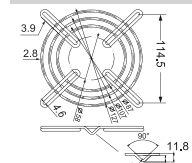

180mm(7") G180-10U

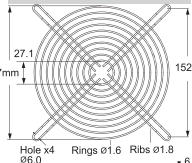

180mm(7") G180-11

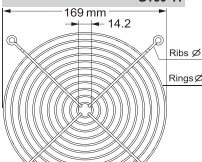

200mm(7.8") G200-12

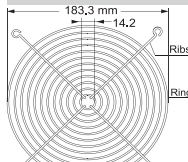

205mm(8.0") G205-6

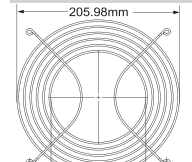

205mm(8.0") G205-8D

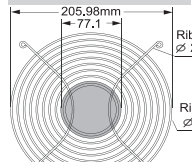

225mm(8.9") G225-5DF

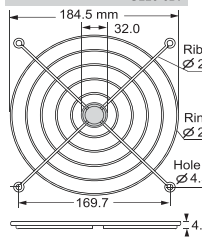

225mm(8.9") GK225-6UT

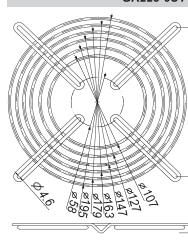

225mm(8.9") GK225-7UT

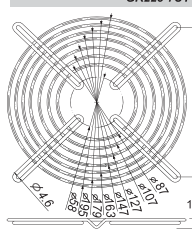

225mm(8.9") G225-9UF

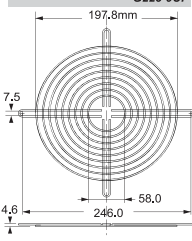

Wire Form, Metal Fan Guards 鐵網

Metal Fan Guards

Steel wires, electroplated finish cosmetics, nickel chrome plated, bright color.
 Black color electro deposit available on request.
 Welding joints strength to meet UL Standards minimum 40kgs (88 lbs) separation force.
 Patterned push-on type wire form metal guards are available on request.
 Customer's design is acceptable & welcome!

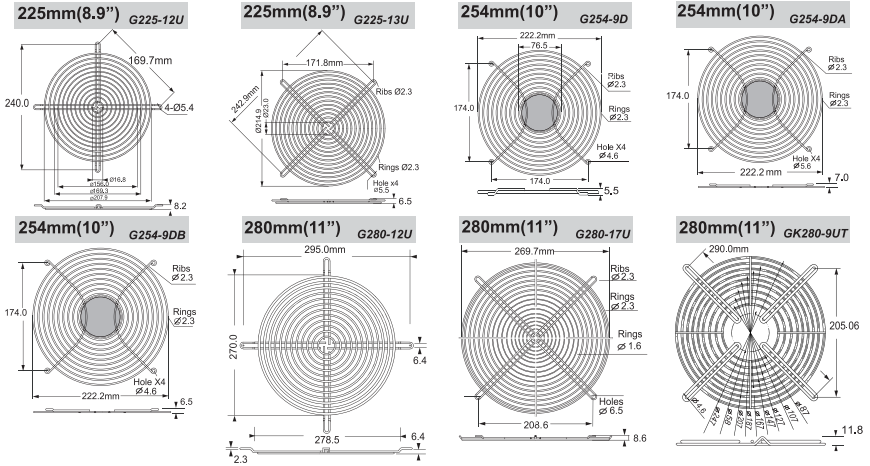

Rib/Grille Fans 柵/肋框網扇



Plastic Fan Guards 塑膠網

Plastic Fan Guards

Glass fiber reinforced ABS UL94V-0 for thru hole types (GxxxP & GxxxP4 series)

Reinforced thermoplastic Nylon UL94-HB for push-on types(GxxxP2 series)

Quality and safety guards full range from 25-300mm (1-11 inch).

Customers' designs and special specifications are welcome!

40mm(1.57") G40P

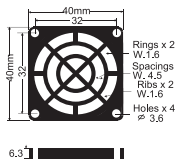

60mm(2.36") G60P

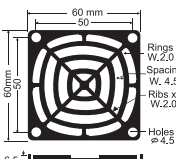

60mm(2.36") G60P2

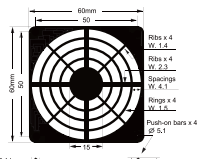

60mm(2.36") G60P4

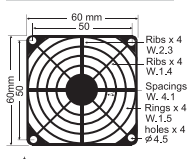

80mm(3.15") G80P

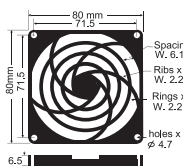

80mm(3.15") G80P2

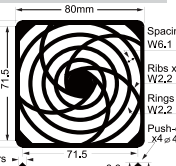

80mm(3.15") G80P4

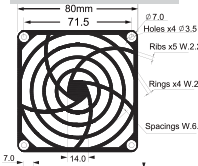

92mm(3.62") G92P25F

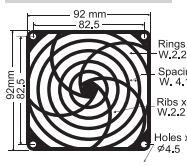

92mm(3.62") G92P

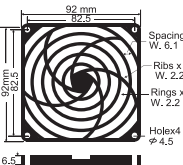

92mm(3.62") G92P2

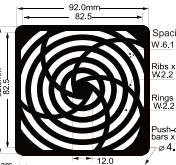

92mm(3.62") G92P4

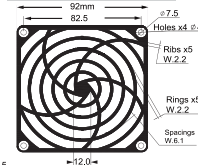

120mm(4.7") G119P2

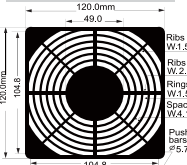

120mm(4.7") G119P4

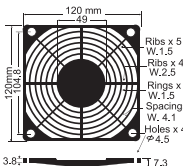

120mm(4.7") G120P

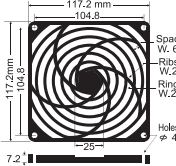

120mm(4.7") G120P2

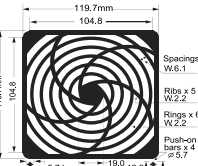

120mm(4.7") G120P4

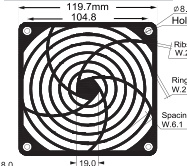

120mm(4.7") G120P25F

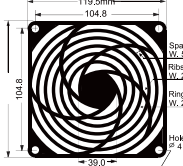

127mm(5") G127P2

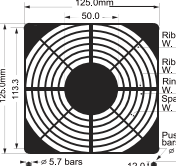

150,172mm(6.7") G172P

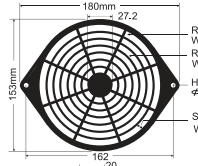

150,172mm(6.7") G172P2

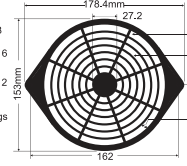





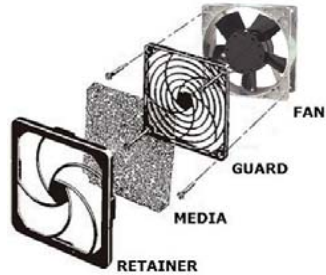
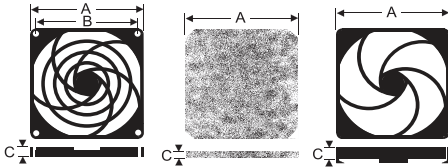

Plastic Filter Kits 塑膠濾網

Plastic Filter Kits



Material: * PU foam for media, mesh 30 or 45 PPI for choice
 * Reinforced ABS UL94V-0 for guard & retainer
 * Standard color black. Any other colors are available on



Miniature	For Fan Size	Part No.	Description	Dimension (mm)		
				A	B	C
	1 9/16" 40 □ mm	G40P R40P M40-30,45 GRM 40-30 GRM 40-45	Guard Retainer Media 30 or 45 PPI Guard + Retainer + Media 30 PPI Guard + Retainer + Media 45 PPI	40.0 37.0 37.0 40.0 40.0	32 32 32 32 32	6.3 3.0 3.0 6.3 6.3
	2 3/8" 60 □ mm	G60P R60P M60-30,45 GRM 60-30 GRM 60-45	Guard Retainer Media 30 or 45 PPI Guard + Retainer + Media 30 PPI Guard + Retainer + Media 45 PPI	60.0 56.2 45.0 60.0 60.0	50 50 50 50 50	6.5 3.2 3.0 6.5 6.5
	3 1/8" 80 □ mm	G80P R80P M80-30,45 GRM 80-30 GRM 80-45	Guard Retainer Media 30 or 45 PPI Guard + Retainer + Media 30 PPI Guard + Retainer + Media 45 PPI	80.0 83.6 78.0 83.6 83.6	71.5 71.5 71.5 71.5 71.5	6.5 9.8 3.0 9.8 9.8
	3 5/8" 92 □ mm	G92P R92P M92-30,45 GRM 92-30 GRM 92-45	Guard Retainer Media 30 or 45 PPI Guard + Retainer + Media 30 PPI Guard + Retainer + Media 45 PPI	92.0 96.5 91 96.5 96.5	82.5 82.5 3.0 82.5 82.5	6.5 9.8 3.0 9.8 9.8
	4 11/16" 120 □ mm	G120P R120P M120-30,45 GRM 120-30 GRM 120-45	Guard Retainer Media 30 or 45 PPI Guard + Retainer + Media 30 PPI Guard + Retainer + Media 45 PPI	117.2 123.7 115.0 123.7 123.7	104.8 104.8 3.0 104.8 104.8	7.2 10.8 3.0 10.8 10.8
	6.7" Ø172,150mm	G172P R172P M172-30,45 GRM 172-30 GRM 172-45	Guard Retainer Media 30 or 45 PPI Guard + Retainer + Media 30 PPI Guard + Retainer + Media 45 PPI	Ø150 Ø180 Ø180 Ø153 Ø180		3 8 8 8 8

Metal Fan Screens 金屬濾網

Metal Fan Screens



General Description

- Tightly woven steel corrugated mesh screen encased in a formed aluminum/stainless steel frame
(*Woven aluminum/stainless steel corrugated mesh screen on request)
- Screen hole mesh 30 PPI normally
- Built for ruggedness and durability, cleanable and easy for service
- Decreasing noise level while creating low air restriction
- To provide maximum airflow with effective filtering

60mm(2.36")
MF60S-30N

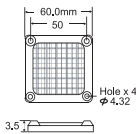

80mm(3.15")
MF80S-30N

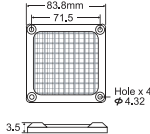

92mm(3.62")
MF92S-30N

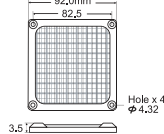

120mm(4.7")
MF120S-30N

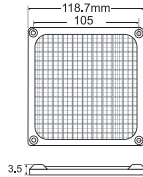

172mm(6")
MF172S-30N

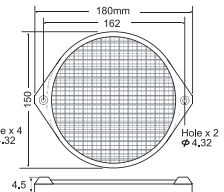

Fan Power Cords

Specifications:

- * Choice of push-in fan terminal pin thickness 0.5 or 0.7mm, to connect 0.5 or 0.7mm fit tab
- * High quality fan plug cords are designed to fit any fans, with cord SPT-1, AWG 18 x 2C, 105C, UL/CSA.
- * Cord lengths described in mm. any lengths will be available on request.
- * Cord ends stripped & tinned or terminated, with connectors available on request.
- * Daisy chains with provisions for multiple fan connections available with any of the four plug head designs or a mixture of the various configurations. Designed to customer's specification.
- * Daisy Chains Model No:
DSC180-05-XXX-AB*-BC*-CD*...-XX
DSC180-05 = Series C45-05/07, C180-05/07, C180B-05/07
XXX = 2AB, 3ABC, 4ABCD, 5ABCDE ...numbers of plug
-AB*-BC*-CD*... * = mm, cord L. between plugs A-B,B-C,C-D...
XX = end cord length, mm

C45-05, C45-07



Angled 45 Degree Type 0.5mm or 0.7mm push-in fit tab

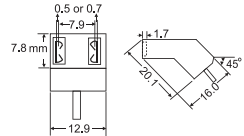

C180-05, C180-07



Straight Type 0.5mm or 0.7mm push-in fit tab

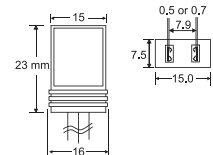

C180B-05, C180B-07



Straight Type 0.5mm or 0.7mm push-in fit tab

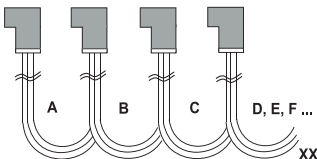
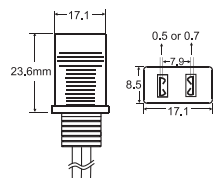

Ventilator Filter Kits 風機濾網組

RFG Kits (Retainer+Filter+Grill=RFG)

Specifications:

- Grille & Retainer (G & R): Made of thermoplastic ABS resin, rated UL94V-0, UV resistance.
- Filter Media (F): Made of polyester fiber. Thickness 10mm.



Anti-UV
IP54



A Type (hinged type)

For Fan Sizes : 3.1~11" / 80~280mm

PROWN Model Series (A Type)	Dimension (WxHxD)	For Fan/Ventilator Size	IP Rating	Features
RFG8092A-IP54-UV	116.5x116.5x33mm	80/92mm (3.1"/3.6")	IP54	ABS, UL94V-0, UV
RFG119A-IP54-UV	156x156x37.3mm	119mm (4.7")	IP54	ABS, UL94V-0, UV
RFG172A-IP54-UV	207x207x47.3mm	150~172mm (5~6.8")	IP54	ABS, UL94V-0, UV
RFG200A-IP54-UV	255x255x48.2mm	200mm (8")	IP54	ABS, UL94V-0, UV
RFG254A-IP54-UV	322x322x48.4mm	254mm (10")	IP54	ABS, UL94V-0, UV
RFG280A-IP54-UV	322x322x48.4mm	280mm (11")	IP54	ABS, UL94V-0, UV



Anti-UV
IP54

B Type (slide type)

For Fan Sizes : 4.7~11" / 119~280mm

PROWN Model Series (B Type)	Dimension (WxHxD)	For Fan/Ventilator Size	IP Rating	Features
RFG119B-IP54-UV	156x156x37.3mm	119mm (4.7")	IP54	ABS, UL94V-0, UV
RFG172B-IP54-UV	209x209x32.3mm	150~172mm (5~6.8")	IP54	ABS, UL94V-0, UV
RFG200B-IP54-UV	258x258x32.8mm	200mm (8")	IP54	ABS, UL94V-0, UV
RFG254B-IP54-UV	317x317x34mm	254mm (10")	IP54	ABS, UL94V-0, UV
RFG280B-IP54-UV	317x317x36.5mm	280mm (11")	IP54	ABS, UL94V-0, UV

AC & DC & EC & 3P Fan Motors / Ventilator

"PROWN" OEM/ODM/OBM Manufacturing, Engineering & Marketing Services

Plastic Fan Filter Nylon Kits 塑膠尼龍濾網

For 40~172mm series Fans
 (40/60/80/92/120/172 mm)

- Plastic guard "G" made of plastic ABS764 glass reinforced flammability rated UL94V-0
 Media is made of Nylon6, 40x32 PPI
 (40X32 holes per sq. inch, *PPI=Porous Per Inch)



AC & Brushless DC Motors 馬達

Inputs available 3~600 Watts



Skeleton Axial Fans 無框扇

Dia. 2.4~12" / 60~305mm
 Airflow 20~1500CFM/ 0.6~42 m³/min



Ribbing Axial Fans 網架扇

Dia. 3~12" / 80~305mm
 Airflow 30~1500CFM/ 0.8~43 m³/min



Box Axial Fans 軸流扇

Dia. 1~13" / 20~330mm
 Airflow 3~1450CFM/ 0.1~41 m³/min



Blowers & Cross Fans 鼓風機 & 橫流扇

Blowers Sizes : 2.5~13" / 90~330mm
 Airflow 30~400CFM/ 0.1~17 m³/min.

Cross Fans Sizes : Fan blades ϕ 1.2~3.5" / ϕ 30~90mm
 Airflow available : 7~730CFM/ 0.2~21 m³/min.





Prown Electric Industries Co., Ltd.

8F.-1, No.18, Ln. 270, Sec. 3, Beishen Rd., Shenkeng Dist.,
New Taipei City 222, Taiwan (R.O.C.)

Tel: +886-2-2664-5557 Fax: +886-2-2664-5567

Email: prownguard@prown.com.tw

www.prown.com.tw

2020
edition

Distributor :

